

PCB 寸法

SPECIFICATION

PERFORMANCE

Electrical Rating: AC/DC 50V 0.5A
 Insulation Resistance: 500MΩ
 Withstand Volt.: 200V AC/minute
 OP Temperature: -25° +85°

MATERIAL

Contact: Phosphor Bronze Gold-Plated
 Housing: LCP

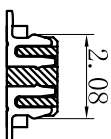
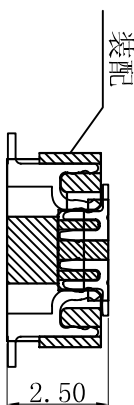

P 数	尺寸			P 数	尺寸		
	A	B	C		A	B	C
4	5.00	2.90	1.50	33	19.50	17.40	16.00
5	5.50	3.40	2.00	34	20.00	17.90	16.50
6	6.00	3.90	2.50	35	20.50	18.40	17.00
7	6.50	4.40	3.00	36	21.00	18.90	17.50
8	7.00	4.90	3.50	37	21.50	19.40	18.00
9	7.50	5.40	4.00	38	22.00	19.90	18.50
10	8.00	5.90	4.50	39	22.50	20.40	19.00
11	8.50	6.40	5.00	40	23.00	20.90	19.50
12	9.00	6.90	5.50	41	23.50	21.40	20.00
13	9.50	7.40	6.00	42	24.00	21.90	20.50
14	10.00	7.90	6.50	43	24.50	22.40	21.00
15	10.50	8.40	7.00	44	25.00	22.90	21.50
16	11.00	8.90	7.50	45	25.50	23.40	22.00
17	11.50	9.40	8.00	46	26.00	23.90	22.50
18	12.00	9.90	8.50	47	26.50	24.40	23.00
19	12.50	10.40	9.00	48	27.00	24.90	23.50
20	13.00	10.90	9.50	49	27.50	25.40	24.00
21	13.50	11.40	10.00	50	28.00	25.90	24.50
22	14.00	11.90	10.50	51	28.50	26.40	25.00
23	14.50	12.40	11.00	52	29.00	26.90	25.50
24	15.00	12.90	11.50	53	29.50	27.40	26.00
25	15.50	13.40	12.00	54	30.00	27.90	26.50
26	16.00	13.90	12.50	55	30.50	28.40	27.00
27	16.50	14.40	13.00				
28	17.00	14.90	13.50				
29	17.50	15.40	14.00				
30	18.00	15.90	14.50				
31	18.50	16.40	15.00				
32	19.00	16.90	15.50				

深圳市文章济美科技有限公司

品名 TITLE	0.5mm	未注公差: GENERAL TOLERANCES	编号 NUMBER	0.5*2.5B2G-1
制图 DRAWING	ZHOUJIANFENG	X ±0.2 X ±0.1 XX ±0.05	材料 MATERIAL	
审核 CHECKED		X° ±1° X° ±0.5° XX° ±0.3°	页号 PAGE NO	
核准 APPROVED			视图 VIEW	比例 SCALE

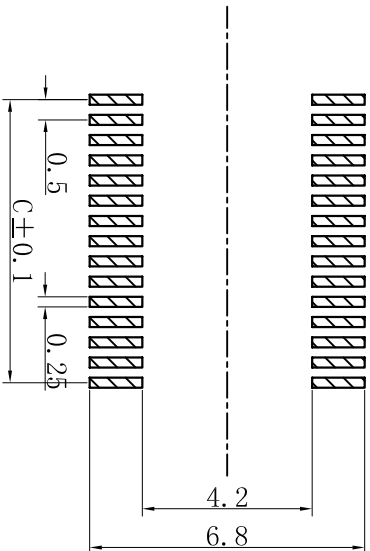
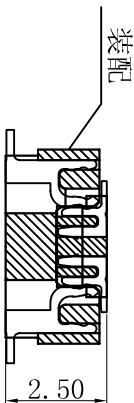
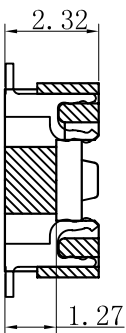
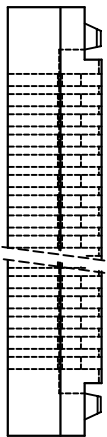
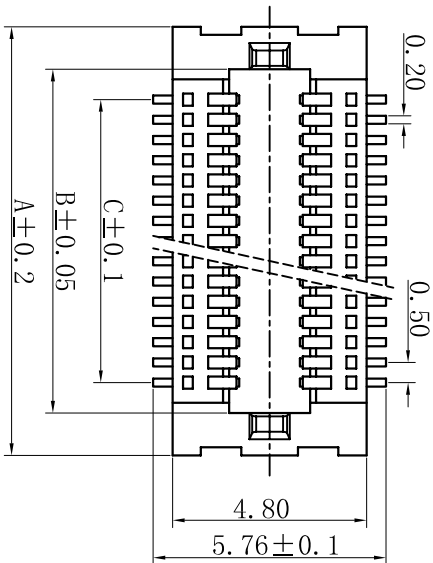

SPECIFICATION

PERFORMANCE

Electrical Rating: AC/DC 50V 0.5A
 Insulation Resistance: 500MΩ
 Withstand Volt: 200V AC/minute
 OP Temperature: -25° +85°

MATERIAL

Contact: Phosphor Bronze Gold-Plated
 Housing: LCP

P 数	尺寸			P 数	尺寸		
	A	B	C		A	B	C
4	5.10	3.00	1.50	33	19.60	17.50	16.00
5	5.60	3.50	2.00	34	20.10	18.00	16.50
6	6.10	4.00	2.50	35	20.60	18.50	17.00
7	6.60	4.50	3.00	36	21.10	19.00	17.50
8	7.10	5.00	3.50	37	21.60	19.50	18.00
9	7.60	5.50	4.00	38	22.1	20.00	18.50
10	8.10	6.00	4.50	39	22.60	20.50	19.00
11	8.60	6.50	5.00	40	23.10	21.00	19.50
12	9.10	7.00	5.50	41	23.60	21.50	20.00
13	9.60	7.50	6.00	42	24.10	22.00	20.50
14	10.10	8.00	6.50	43	24.60	22.50	21.00
15	10.60	8.50	7.00	44	25.10	23.00	21.50
16	11.10	9.00	7.50	45	25.60	23.50	22.00
17	11.60	9.50	8.00	46	26.10	24.00	22.50
18	12.10	10.00	8.50	47	26.60	24.50	23.00
19	12.60	10.50	9.00	48	27.10	25.00	23.50
20	13.10	11.00	9.50	49	27.60	25.50	24.00
21	13.60	11.50	10.00	50	28.10	26.00	24.50
22	14.10	12.00	10.50	51	28.60	26.50	25.00
23	14.60	12.50	11.00	52	29.10	27.00	25.50
24	15.10	13.00	11.50	53	29.60	27.50	26.00
25	15.60	13.50	12.00	54	30.10	28.00	26.50
26	16.10	14.00	12.50	55	30.60	28.50	27.00
27	16.60	14.50	13.00				
28	17.10	15.00	13.50				
29	17.60	15.50	14.00				
30	18.10	16.00	14.50				
31	18.60	16.50	15.00				
32	19.10	17.00	15.50				

深圳市文章济美科技有限公司

品名 TITLE	0.5mm	未注公差: GENERAL TOLERANCES	编号 NUMBER	0.5*2.5B2M-1
制图 DRAWING	ZHOUJIANFENG	X ±0.2 X ±0.1 XX ±0.05	材质 MATERIAL	
审核 CHECKED		X° ±1° X° ±0.5° XX° ±0.3°	页号 DWG. NO	
核准 APPROVED			视角 PROJ	单位 UNIT
				比例 SCALE

PCB 寸法