

MATING HEIGHT

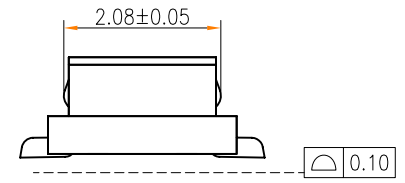

NOTES:

- HUOSING: PA9T HIGH-TEMP THERMOPLASTIC UL94V-0 COLOR:BLACK
- TERMINAL:PHOSPHOR BRONZE  
PLATING:1μ" GOLD FLASH OVERALL 50~100μ" NICKEL UNDER PLATED.
- CODING INFORMATION:5001-BTB 0515- \*\* M R

PACKING : R: REEL  
MALE  
PIN  
MATING HEIGHT : 15-1.5H  
0.5BTB  
JM CONN BTB CONNECTOR SERIES

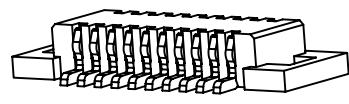

3D VIEW

HIGH	MALE	FEMALE H1	FEMALE H2
1.50	1.3	0.9	1.35
2.00	1.3	1.4	1.85
2.50	1.3	1.9	2.35

NO.of contacts	Dimensions			
	A.	B.	C.	D.
10	5.50	2.00	3.45	4.96
12	6.00	2.50	3.95	5.46
16	7.00	3.50	4.95	6.46
18	7.50	4.00	5.45	6.96
20	8.00	4.50	5.95	7.46
14	6.50	3.00	4.45	5.96
16	7.00	3.50	4.95	6.46
18	7.50	4.00	5.45	6.96
20	8.00	4.50	5.95	7.46
22	8.50	5.00	6.45	7.96
24	9.00	5.50	6.95	8.46
26	9.50	6.00	7.45	8.96
28	10.00	6.50	7.95	9.46
30	10.50	7.00	8.45	9.96
32	11.00	7.50	8.95	10.46
36	12.00	8.50	9.95	11.46
40	13.00	9.50	10.95	12.46
50	15.50	12.00	13.45	14.96
100	28.00	24.50	25.95	27.46

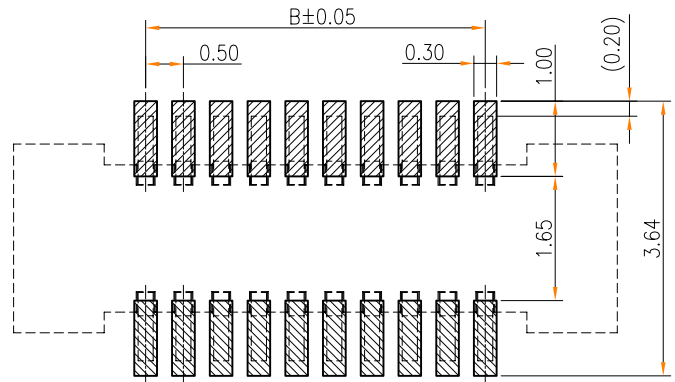

RECOMMENDED PCB PATTERN DIM.  
TOLERANCE : ±0.05

<b>CUSTOMER</b>		<b>深圳市文章济美科技有限公司</b>			
一般公差 GENERAL TOLERANCE	Kavin 2016.07.05	品名(TITLE): 0.5mm 单槽BTB MALE			
.X ±0.25 .XX ±0.15 .XXX ±0.05 ANGLES ±1°	制图(CRD):	料号(PART NO.): 5001-BTB0515- **MR			
版本 (REV) B	审核 (CHKD):	比例(SCALE): 1:8	单位(UNITS): mm	张数(SHEET): 1 OF 1	图幅(SIZE): A4
核准 (APPD):					

新增CAP规格	Kavin	02/17/17'
产品料号修正	Kavin	12/01/16'
修订 REV	修改摘要 REVISION DESCRIPTION	签名 SIGNATURE
		日期 DATE



NOTES:

- 1.HUOSING: PA9T HIGH-TEMP THERMOPLASTIC UL94V-0 COLOR:BLACK
- 2.TERMINAL:PHOSPHOR BRONZE  
PLATING:1μ" GOLD FLASH OVERALL 50~100μ" NICKEL UNDER PLATED.
- 3.CODING INFORMATION:5001-BTB 0515- \*\* F R

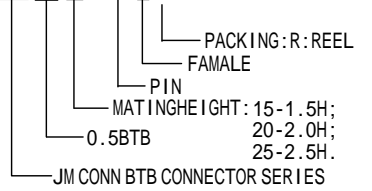

	HIGH	MALE	FEMALE H1	FEMALE H2
	1.50	1.3	0.9	1.35
	2.00	1.3	1.4	1.85
	2.50	1.3	1.9	2.35

NO.of contacts	Dimensions			
	A.	B.	C.	D.
10	5.60	2.00	3.50	3.90
12	6.10	2.50	4.00	4.40
16	7.10	3.50	5.00	5.40
18	7.60	4.00	5.50	5.90
20	8.10	4.50	6.00	6.40
14	6.60	3.00	4.50	4.90
16	7.10	3.50	5.00	5.40
18	7.60	4.00	5.50	5.90
20	8.10	4.50	6.00	6.40
22	8.60	5.00	6.50	6.90
24	9.10	5.50	7.00	7.40
26	9.60	6.00	7.50	7.90
28	10.10	6.50	8.00	8.40
30	10.60	7.00	8.50	8.90
32	11.10	7.50	9.00	9.40
36	12.10	8.50	10.00	10.40
40	13.10	9.50	11.00	11.40
50	15.60	12.00	13.50	13.90
100	28.10	24.50	26.00	26.40

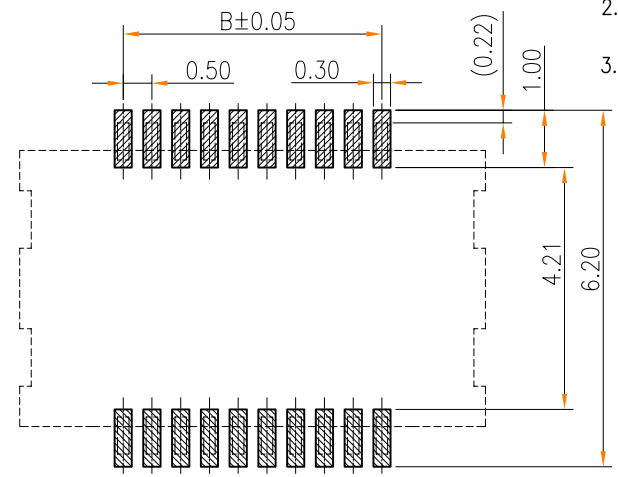
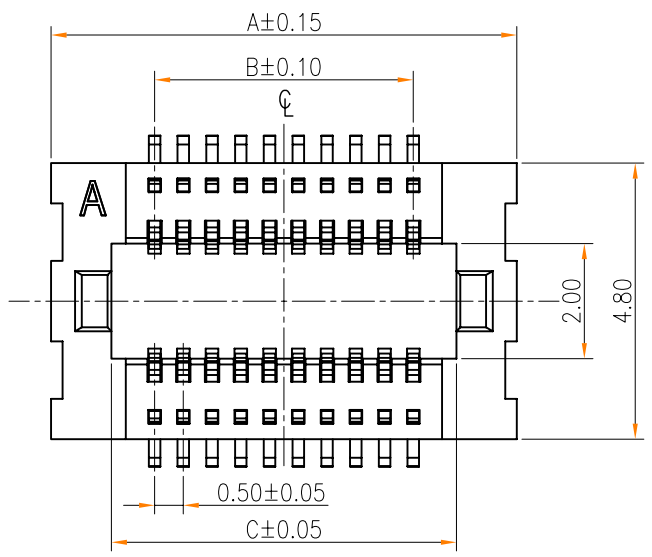

RECOMMENDED PCB PATTERN DIM.  
TOLERANCE : ±0.05

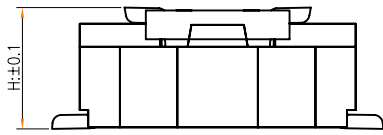
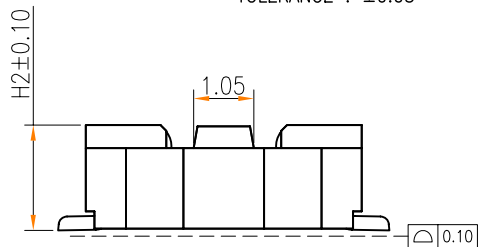
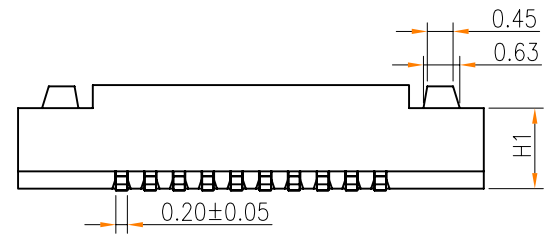

MATING HEIGHT

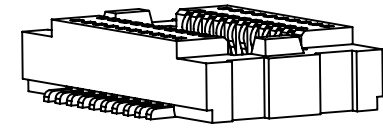

3D VIEW

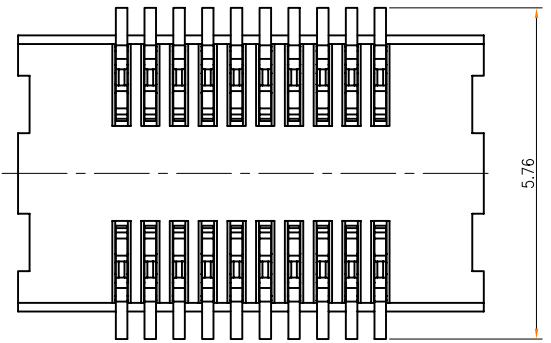

CUSTOMER		深圳市文章济美科技有限公司			
一般公差 GENERAL TOLERANCE .X ±0.25 .XX ±0.15 .XXX ±0.05 ANGLES ±1°		制图 (DR): Kavin 2016.02.05	品名 (TITLE): 0.5mm 双槽BTB FEMALE		
版本 (REV) B		审核 (CHKD):	料号 (PART NO): 5001-BTB0515**FR		
核淮 (APPD):		比例 (SCALE): 1:8	单位 (UNITS): mm	张数 (SHEET): 1 OF 1	图幅 (SIZE): A4

修订 (REV)	修改摘要 (REVISION DESCRIPTION)	签名 (SIGNATURE)	日期 (DATE)
1	新增CAP规格	Kavin	02/17/17
2	产品料号修正	Kavin	12/01/16

