

NOTES:

- 1.HOUSING: LCP HIGH-TEMP THERMOPLASTIC UL94V-0 COLOR:BLACK
- 2.TERMINAL/GROUND PLANE:PHOSPHOR BRONZE  
PLATING:10u" GOLD IN CONTACT AREA, MATTE TIN ON TAIL.
- 3.CODING INFORMATION: 5001-BTB 0542-\*\* M R

PACKING: R: REEL  
MALE  
PIN  
MATING HEIGHT: 42-4.26H  
0.5BTB  
JM CONN BTB CONNECTOR SERIES

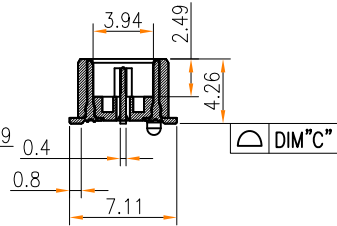
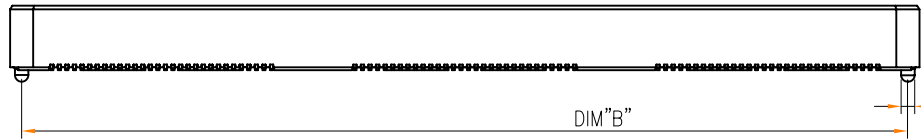

SECTION A-A

NO. of contacts	Dimensions		
	A.	B.	C.
60	20.00	18.48	0.10
120	40.00	38.48	0.10
180	60.00	58.48	0.15
240	80.00	78.48	0.15
300	100.00	98.48	0.15

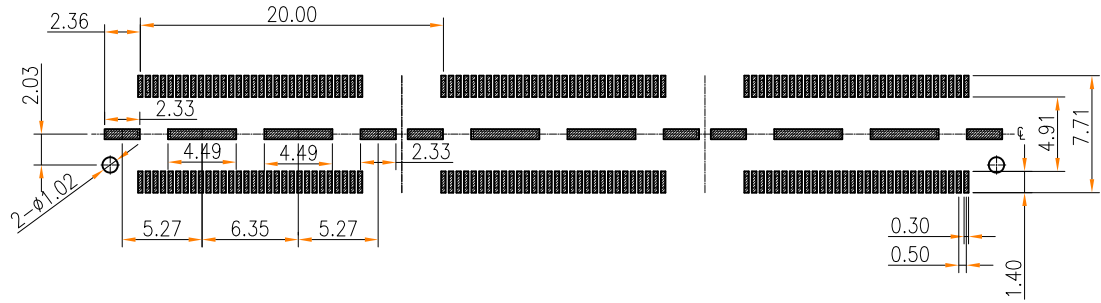
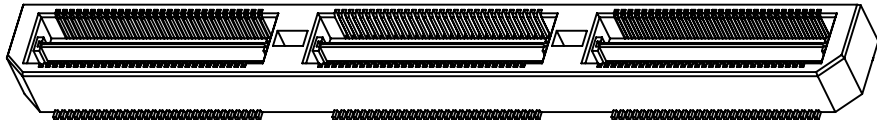
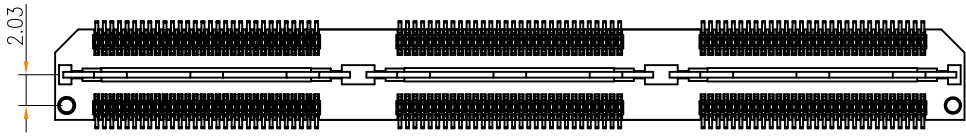

CUSTOMER		深圳市文章济美科技有限公司			
一般公差 GENERAL TOLERANCE .X ±0.30 .XX ±0.20 .XXX ±0.10 ANGLES ±0° 30'		制图 (DR): Lu junhui 2018.12.11	品名(TITLE): 0.5mm DOUBLE ROW BTB H4.26		
审核 (CHKD):		料号(PART NO): 5001-BTB0542-**MR			
版本 (REV):	A	比例(SCALE): 1:1	单位(UNITS): mm	张数(SHEET): 1 OF 1	图幅(SIZE): A4
核准 (APPD):					



修订 (REV)	修改摘要 (REVISION DESCRIPTION)	签名 (SIGNATURE)	日期 (DATE)

NOTES:

- 1.HOUSING: LCP HIGH-TEMP THERMOPLASTIC UL94V-0 COLOR:BLACK
- 2.TERMINAL/GROUND PLANE:PHOSPHOR BRONZE  
PLATING:10u" GOLD IN CONTACT AREA, MATTE TIN ON TAIL.
- 3.CODING INFORMATION: 5001-BTB 0532-\*\* F R

PACKING: R: REEL  
FEMALE  
PIN  
MATING HEIGHT: 32-3.25H  
0.5BTB  
JM CONN BTB CONNECTOR SERIES

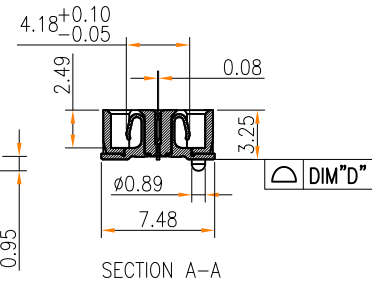
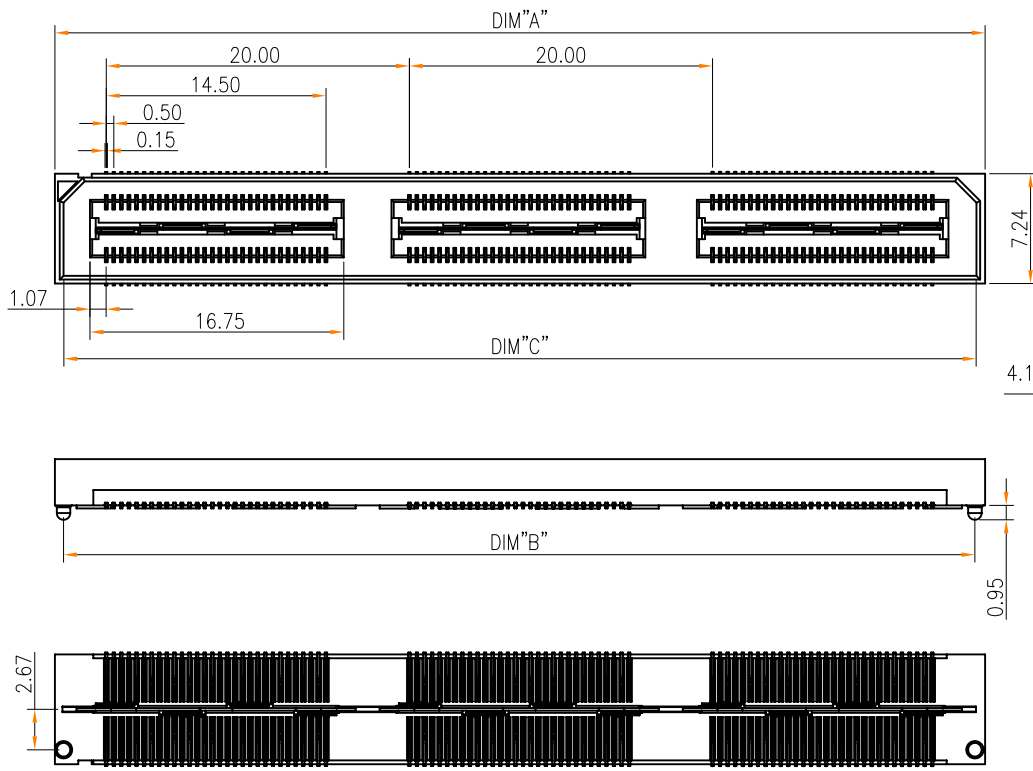

NO. of contacts	Dimensions			
	A.	B.	C.	D.
60	21.38	20.13	20.18	0.10
120	41.38	40.13	40.18	0.10
180	61.38	60.13	60.18	0.15
240	81.38	80.13	80.18	0.15
300	101.38	100.13	100.18	0.15

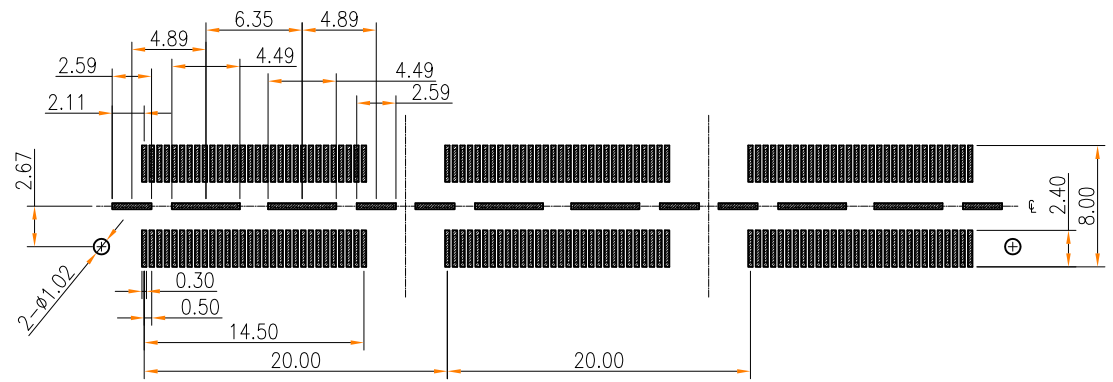
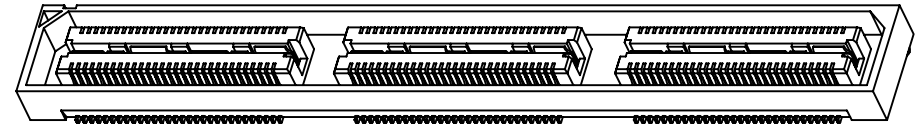

RECOMMENDED PCB PATTERN DIM.  
TOLERANCE : ±0.05

CUSTOMER		深圳市文章济美科技有限公司			
一般公差 GENERAL TOLERANCE		Lu Junhui 2018.12.11	品名(TITLE): 0.5mm DOUBLE ROW BTB H3.25		
.X ±0.30 .XX ±0.20 .XXX ±0.10 ANGLES ±0° 30'		审核 (CHKD):	料号(PART NO): 5001-BTB0532-**FR		
修订 SER	修改摘要 REVISION DESCRIPTION	签名 SIGNATURE	日期 DATE	版本 (REV) A	核准 (APPD):
		比例(SCALE) 1:1	单位(UNITS) mm	张数(SHEET) 1 OF 1	图幅(SIZE) A4